





























**LEGEND**

-  ELECTRICAL SERVICES SWITCHBOARD.
-  SWITCHBOARD / CONTROL PANEL NOT PROVIDED AS PART OF THE ELECTRICAL SUBCONTRACT.
-  SINGLE POWER OUTLET.
-  DOUBLE POWER OUTLET.
-  SPECIAL PURPOSE POWER OUTLET.
-  SINGLE PHASE ISOLATOR.
-  THREE PHASE ISOLATOR.
-  ONE-WAY LIGHT SWITCH.
-  TWO-WAY LIGHT SWITCH.
-  DALI LIGHT SWITCH.
-  CIRCUIT LINE.
-  SWITCH LINE.
-  DB-x - Py POWER CIRCUIT DESIGNATION. DENOTES DB AND CIRCUIT.
-  ELECTRICAL EQUIPMENT AS NOTED.
-  RJ45 COMMUNICATIONS OUTLET.
-  PA MULTI-TAP CONE SPEAKER.
-  REFER TO DETAIL NOTED FOR THE AREA SHOWN HATCHED. ADDITIONAL OUTLETS & FITTINGS MAY BE SHOWN ON DETAIL.
-  E1: RECESSED LED EMERGENCY LIGHT.
-  E2: WALL MOUNTED LED EMERGENCY LIGHT.
-  EX: EMERGENCY LED EXIT LIGHT.
-  L1: 300 x 1200 LED FLAT PLATE FITTING.
-  L2: RECESSED DOWNLIGHT, DIMMABLE.
-  L3: RECESSED DOWNLIGHT.
-  L4: RECESSED DOWNLIGHT.
-  L5: RECESSED ADJUSTABLE DOWNLIGHT.
-  L6: 3000 LONG RECESSED 35 x 35 LED EXTRUSION LIGHT.
-  L7: 2000 LONG RECESSED 35 x 35 LED EXTRUSION LIGHT.
-  L8: 1200 LONG RECESSED 35 x 35 LED EXTRUSION LIGHT.

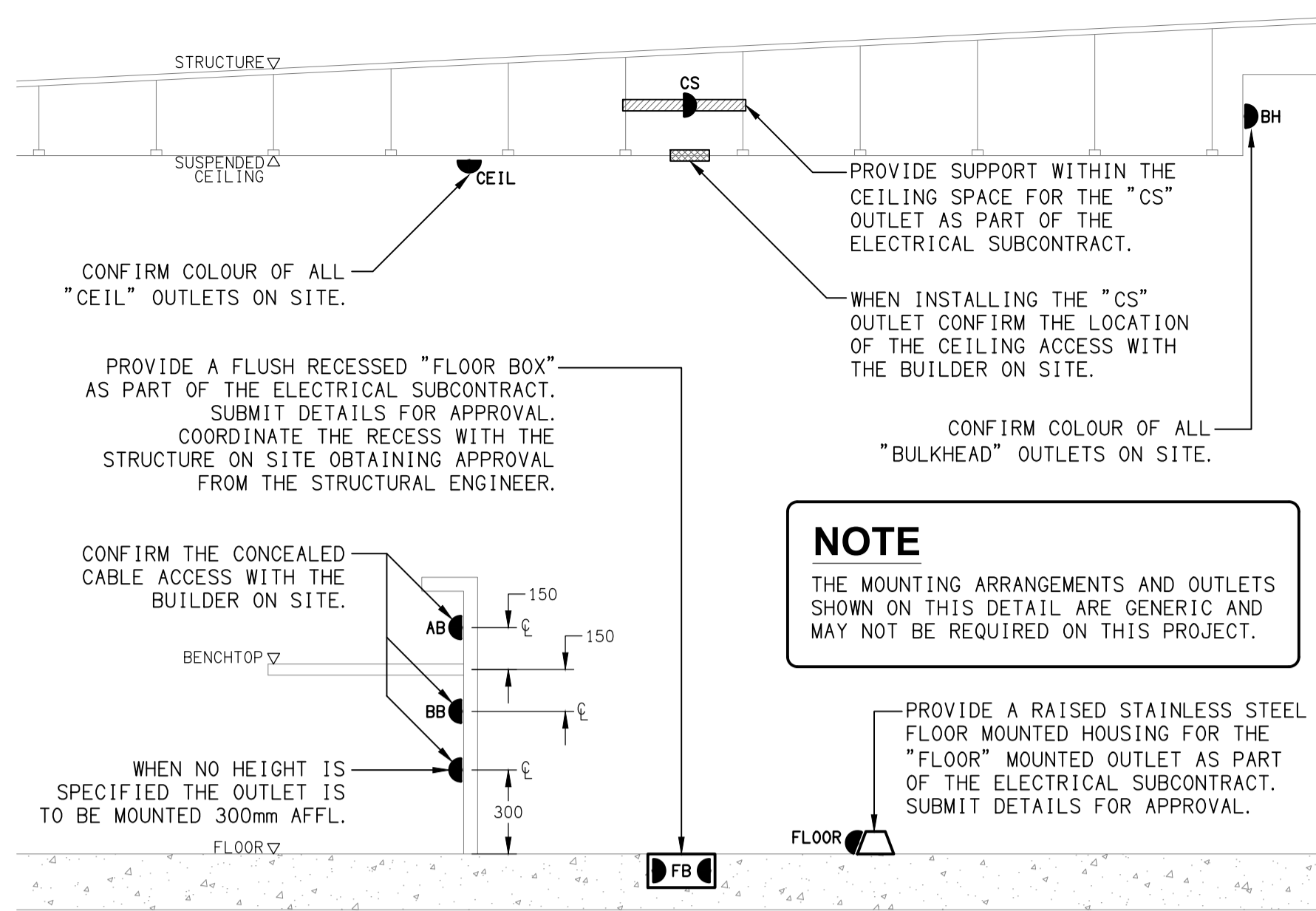

**DETAIL**  
TYPICAL OUTLET MOUNTINGS  
NOT TO SCALE

**EQUIPMENT:**

- TEST - TEST PUSH BUTTON MOUNTED ON THE DISTRIBUTION BOARD ESCUTCHEON.
- RESET - RESET PUSH BUTTON MOUNTED ON THE DISTRIBUTION BOARD ESCUTCHEON.
- LAMP - AMBER TEST INDICATING LAMP MOUNTED ON THE DISTRIBUTION BOARD ESCUTCHEON.
- Ta - ADJUSTABLE 0-3 HOUR TIMED RELAY.
- Tb - 15 MINUTE RUN-ON TIMER TO OPERATE UPON THE RETURN OF MAINS POWER.
- Cx - CONTACTOR x.
- CRx - CONTROL RELAY x.
- Rx - RELAY x.

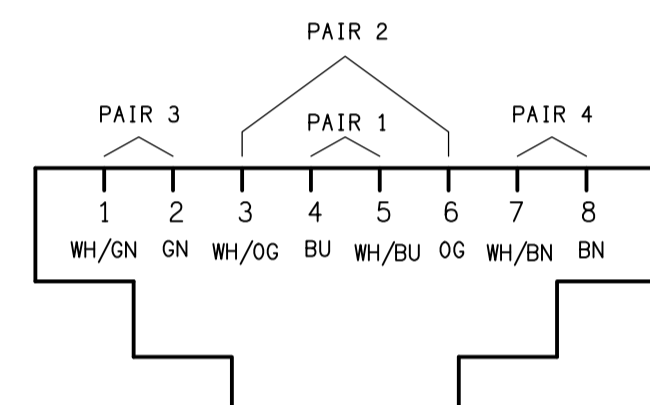

**SCHEMATIC**  
RJ45 PINOUT CONFIGURATION  
NOT TO SCALE

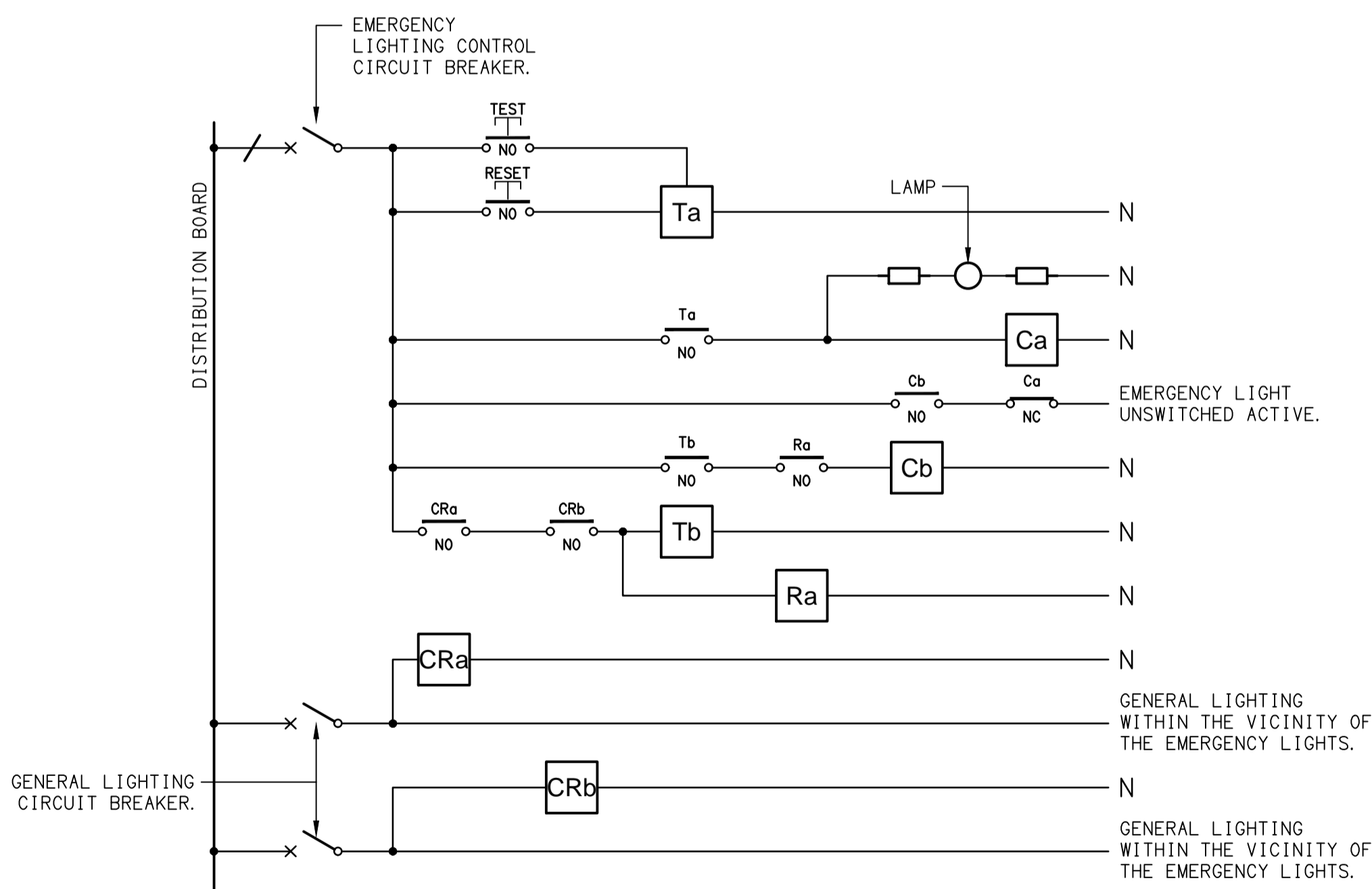

**NOTES**

1. THE EMERGENCY LIGHT UNSWITCHED ACTIVE / GENERAL LIGHTING SWITCHED ACTIVE CIRCUIT ARRANGEMENT AND CONTROL IS TYPICAL FOR ALL CIRCUITS SUPPLYING EMERGENCY LIGHTS.
2. PROVIDE ADDITIONAL CONTROL RELAYS (CRx) CONFIGURED AS PER CRa AND CRb FOR ALL ADDITIONAL LIGHTING CIRCUITS THAT SUPPLY LIGHTS IN THE VICINITY OF THE EMERGENCY LIGHTS.

**SCHEMATIC**  
EMERGENCY LIGHTING  
NOT TO SCALE

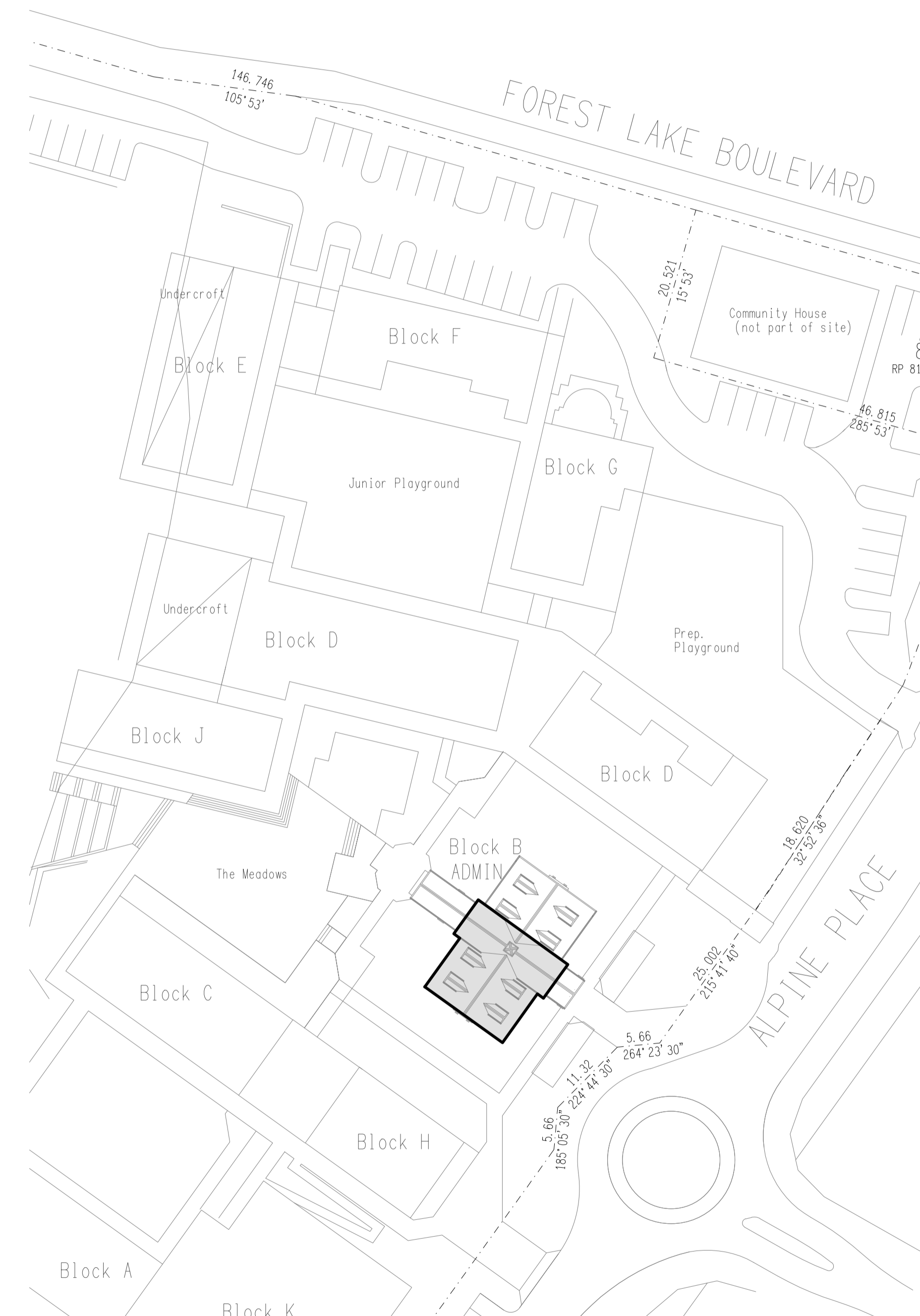

**SITE PLAN**  
ADMINISTRATION BUILDING UPGRADE  
SCALE 1:500

|  |  |   |  |   |                |            |                   |       |
|--|--|---|--|---|----------------|------------|-------------------|-------|
| <p>ELECTRICAL DESIGN GROUP BRISBANE PTY LTD<br/>ACN 092 710 793</p> <p>TRADING AS:<br/>ELECTRICAL DESIGN GROUP</p> | <p>THE COPYRIGHT OF THIS DRAWING REMAINS THE PROPERTY OF THE ELECTRICAL DESIGN GROUP.</p> <p>USE FIGURED DIMENSIONS IN PREFERENCE TO SCALE.</p> <p>ALL DIMENSIONS TO BE VERIFIED ONSITE.</p> | <p><b>ELECTRICAL DESIGN GROUP</b><br/>ELECTRICAL BUILDING SERVICES CONSULTANTS<br/>BRISBANE GOLD COAST</p> <p>P.O. Box 15, Sherwood Q.4075<br/>Phone: (07) 3278 4375<br/>Email: brisbane@edg.net.au<br/>Web: www.edg.net.au</p> | <p>PROJECT:<br/><b>ST JOHNS ANGLICAN COLLEGE,<br/>FOREST LAKE - JUNIOR CAMPUS<br/>ADMINISTRATION UPGRADE</b><br/>ALPINE PLACE, FOREST LAKE, QUEENSLAND</p> | <table border="1" style="width: 100%; border-collapse: collapse;"> <tr> <td style="width: 50%;">E CONSTRUCTION</td> <td style="width: 50%;">16/12/2025</td> </tr> <tr> <td>REV: DESCRIPTION:</td> <td>DATE:</td> </tr> </table> <p>DRAWING:<br/><b>ELECTRICAL SERVICES<br/>LEGEND, DETAILS &amp; SITE PLAN</b></p> <p>SCALE:<br/>1:500 UNO AT A1</p> <p>PROJECT NO:<br/><b>C3613a</b></p> <p>DRAWING NO:<br/><b>E01</b></p> <p>REVISION:<br/><b>E</b></p> | E CONSTRUCTION | 16/12/2025 | REV: DESCRIPTION: | DATE: |
| E CONSTRUCTION   | 16/12/2025   |   |  |   |                |            |                   |       |
| REV: DESCRIPTION:  | DATE:  |   |  |   |                |            |                   |       |